

Silicon Schottky Diode

- Low barrier diode for detectors up to GHz frequencies

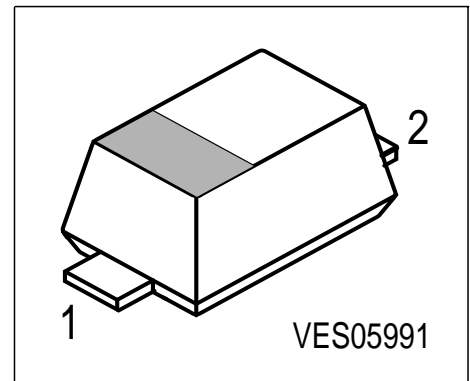

ESD: Electrostatic discharge sensitive device, observe handling precaution

Type	Marking	Ordering Code	Pin Configuration		Package
BAT 62-02W	L	Q62702-A1028	1 = C	2 = A	SCD-80

Maximum Ratings

Parameter	Symbol	Value	Unit
Diode reverse voltage	V_R	40	V
Forward current	I_F	40	mA
Junction temperature	T_j	150	°C
Storage temperature	T_{stg}	-55 ...+150	

Thermal Resistance

Junction - ambient ¹⁾	R_{thJA}	≤ 650	K/W
Junction - soldering point	R_{thJS}	≤ 810	

1) Package mounted on epoxy pcb 15mm x 16.7mm x 0.7mm

Electrical Characteristics at $T_A = 25^\circ\text{C}$, unless otherwise specified.

Parameter	Symbol	Values			Unit
		min.	typ.	max.	
DC characteristics					
Reverse current $V_R = 40\text{ V}$	I_R	-	-	10	μA
Forward voltage $I_F = 2\text{ mA}$	V_F	-	0.58	1	V
AC characteristics					
Diode capacitance $V_R = 1\text{ V}, f = 1\text{ MHz}$	C_T	-	0.35	0.6	pF
Case capacitance $f = 1\text{ MHz}$	C_C	-	0.09	-	
Differential resistance $V_R = 0, f = 10\text{ kHz}$	R_0	-	225	-	k Ω
Series inductance chip to ground	L_s	-	0.6	-	nH

Forward current $I_F = f(T_A^*; T_S)$

* Package mounted on epoxy

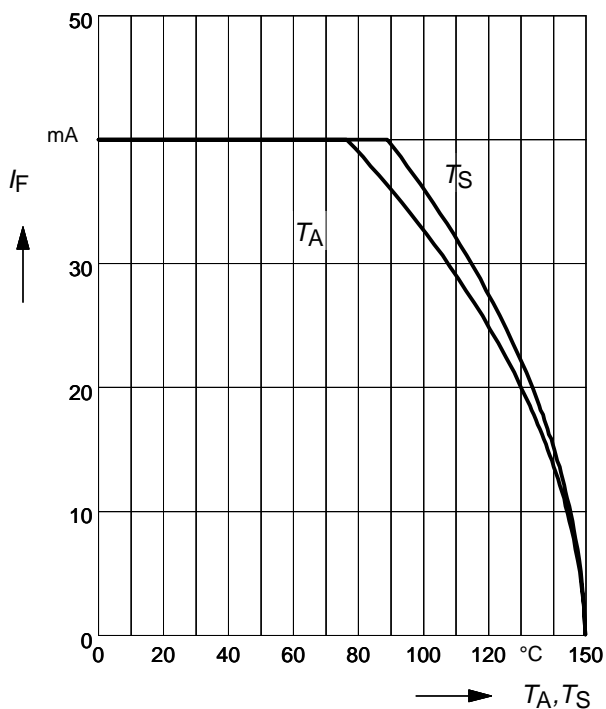

Permissible Pulse Load $R_{thJS} = f(t_p)$

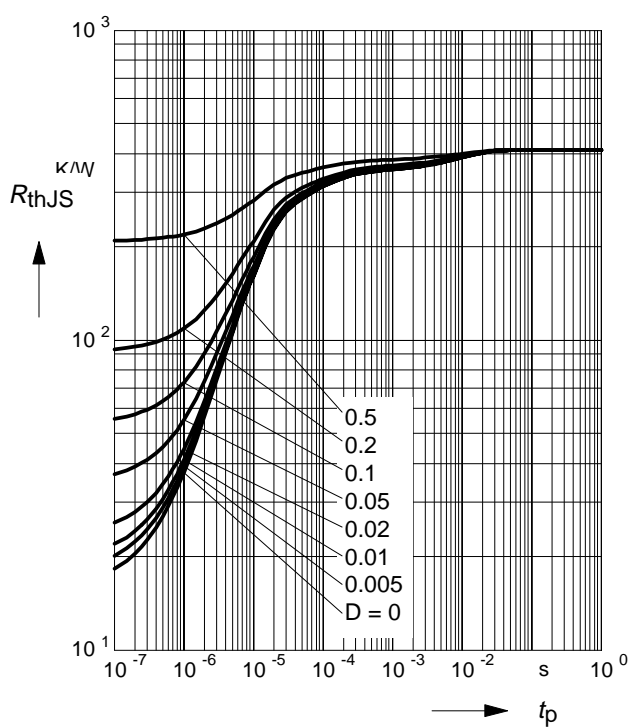

Permissible Pulse Load

$I_{Fmax} / I_{FDC} = f(t_p)$

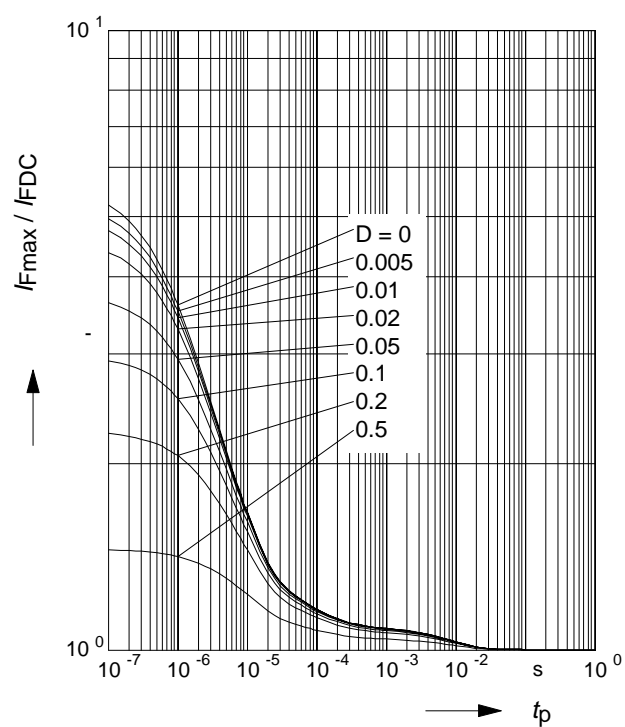

Forward current $I_F = f(V_F)$

$T_A = \text{parameter}$

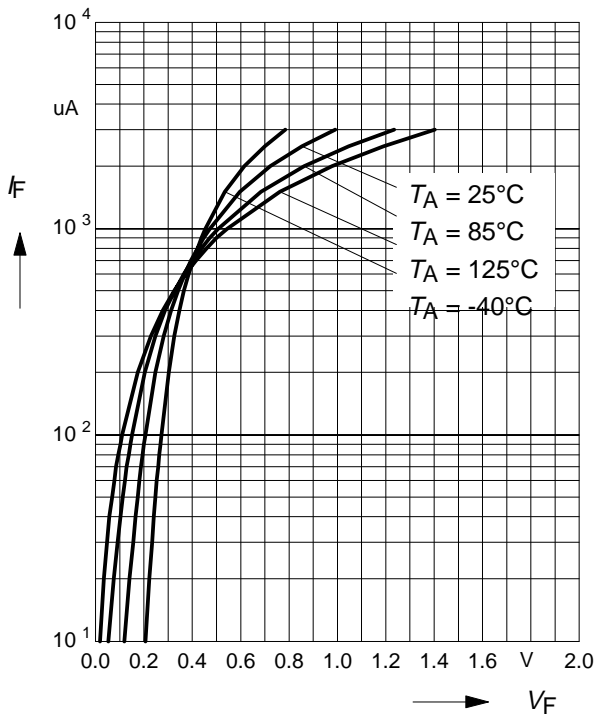

Leakage current $I_R = f(V_R)$

$T_A = \text{Parameter}$

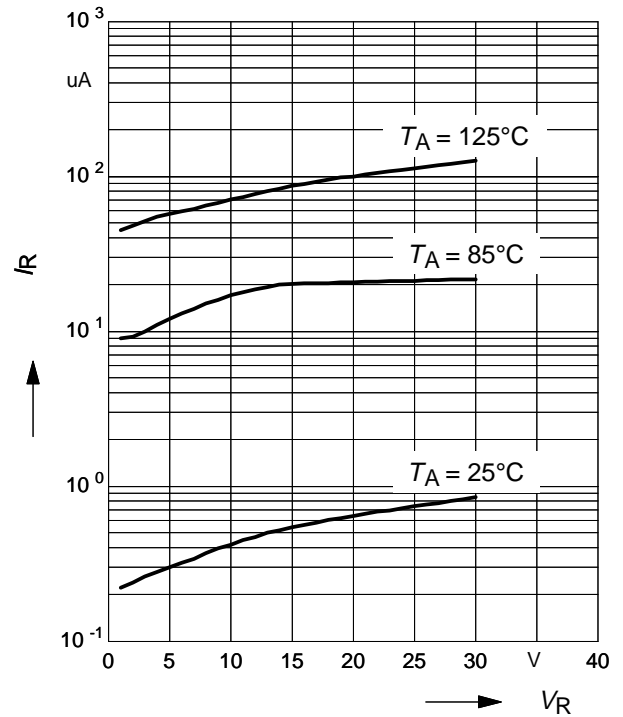

Diode capacitance $C_T = f(V_R)$

$f = 1\text{MHz}$

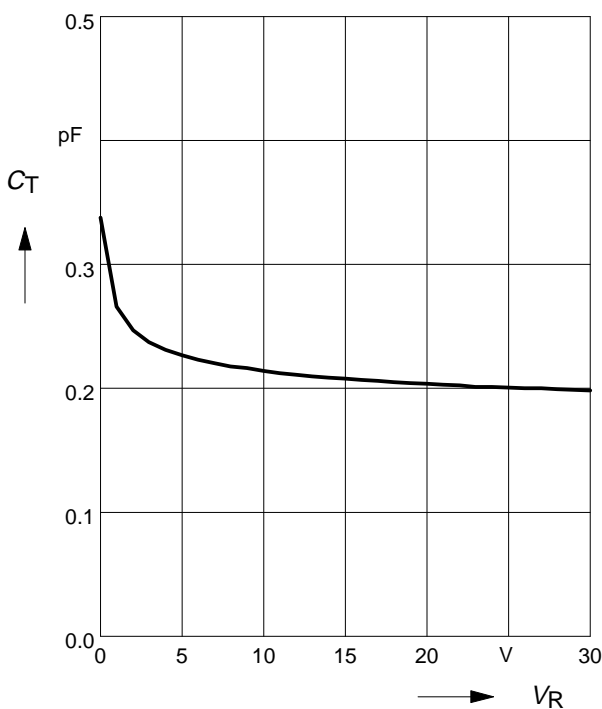

Rectifier voltage $V_{out} = f(V_{in})$

$f = 900\text{ MHz}$

$R_L = \text{parameter in k}\Omega$

